

Temat : Modelowanie tradycyjne 3D – DETAL 1

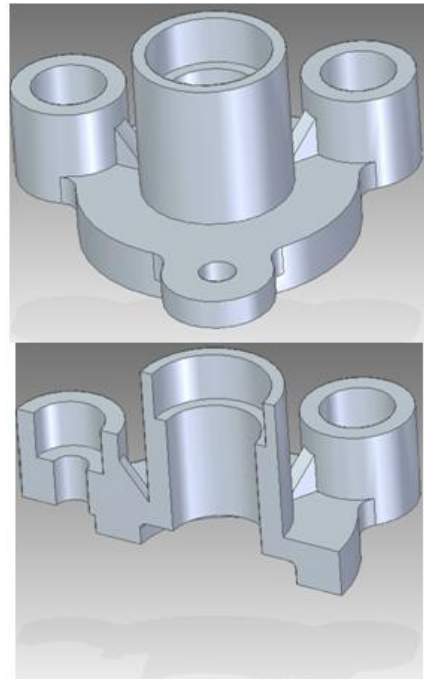

Krok 1: Wyciągnięcie 1

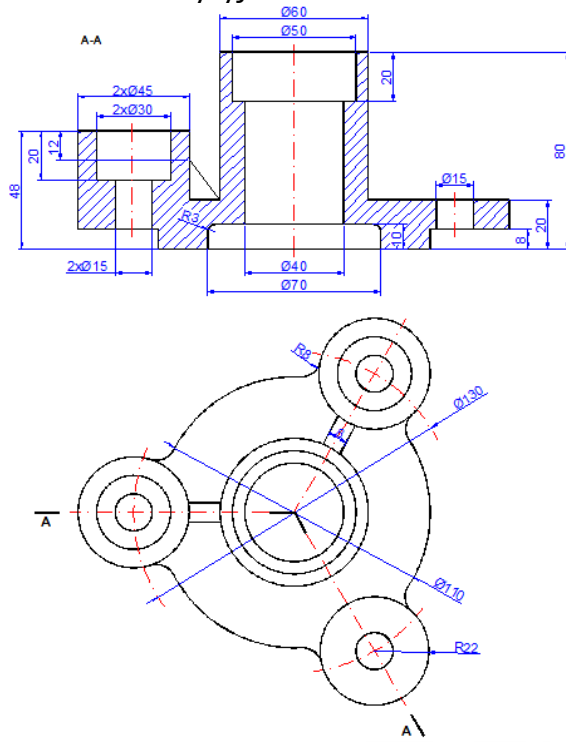
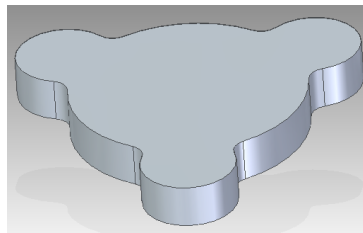
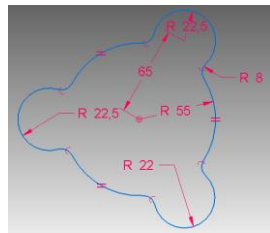

Krok 2: Wycięcie 1

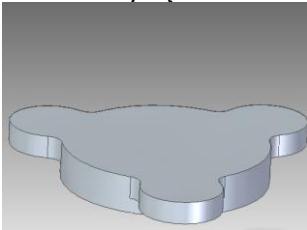

Krok 3: Otwór 1

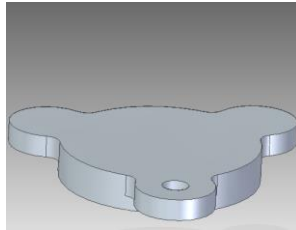

Krok 4: Wyciągnięcie 2

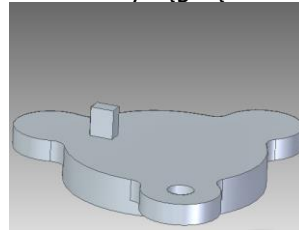

Krok 5: Wycięcie obrotowe

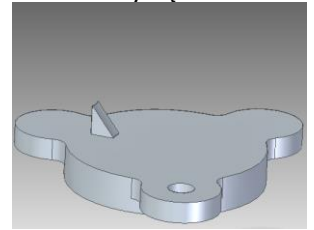

Krok 6: Szyk

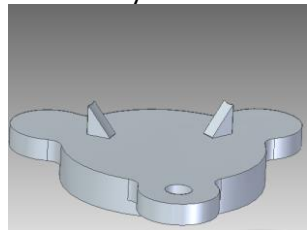

Krok 7: Wyciągnięcie 3

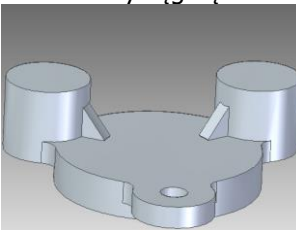

Krok 8: Wyciągnięcie 4

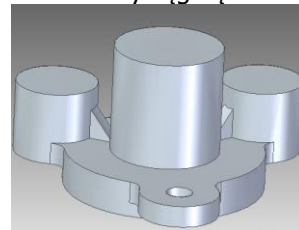

Krok 9: Otwór 2

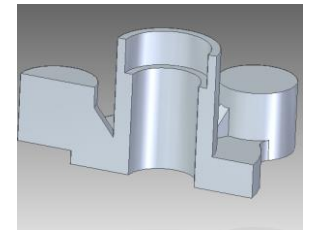

Krok 10: Wycięcie 2

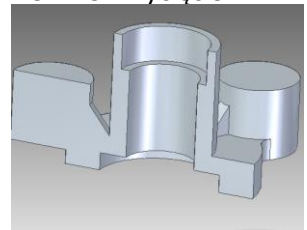

Krok 11: Zaokrąglenie

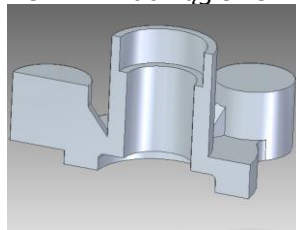

Krok 12: Otwór 3

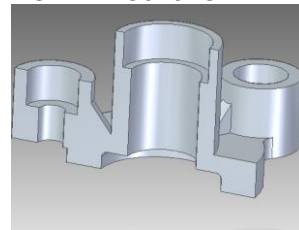

Solid Edge ST5

Temat : Modelowanie tradycyjne 3D – DETAL 1

